

# ASSEMBLY GUIDE

## Harmony Piano Easy Assembly

harmony

Stage Piano Stand

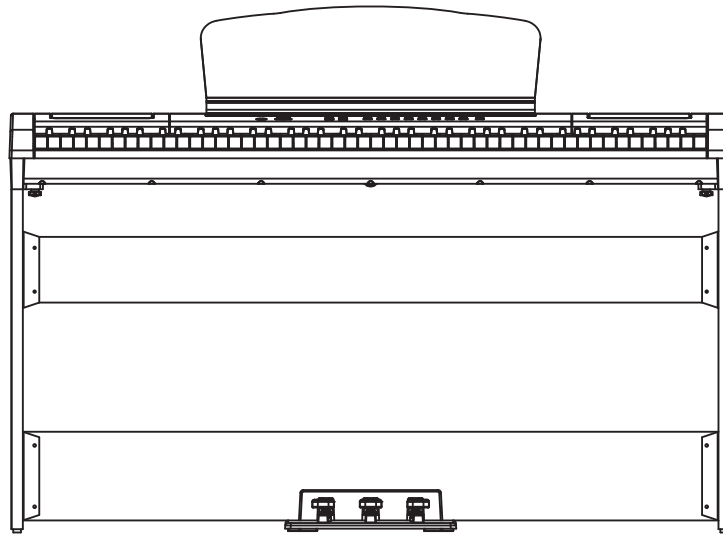

---

## EASY ASSEMBLY GUIDE

If You Have Any Questions Or Problems

Please Call Our Toll Free Helpline:



**888-998-9848**



**Do Not Return To The Store**

artesia

# Assembling Your Furniture Stand

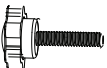
## What's Included

- A**  x2 M6 Barrel Nuts
- C**  x2 Screw Caps
- E**  x4 M5x25 Hand Bolts

- B**  x2 M6x55 Bolt Screws
- D**  x4 M4x25 Bolt Screws

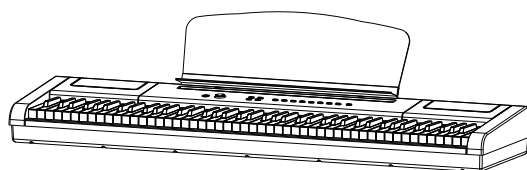

Piano

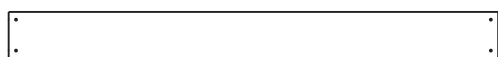

Crosspiece

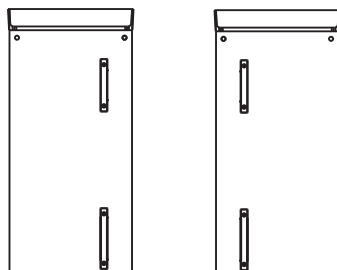

Left and Right Legs

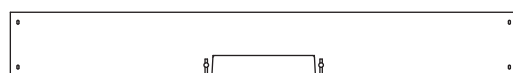

Pedal Board

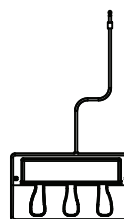

3-Pedal

## 1. Assembling the Pedal Board.

Begin assembling the piano by attaching the 3-pedal mechanism to the pedal board.

### Step 1

Begin by inserting two barrel nuts (A) into the pedal crosspiece board, as shown.

### Step 2

Put the barrel nut into the pedal board as shown, make sure it is in the proper position to receive the inserted screw. Please make sure to properly fasten the bolt through the pedal board and into the barrel nut.

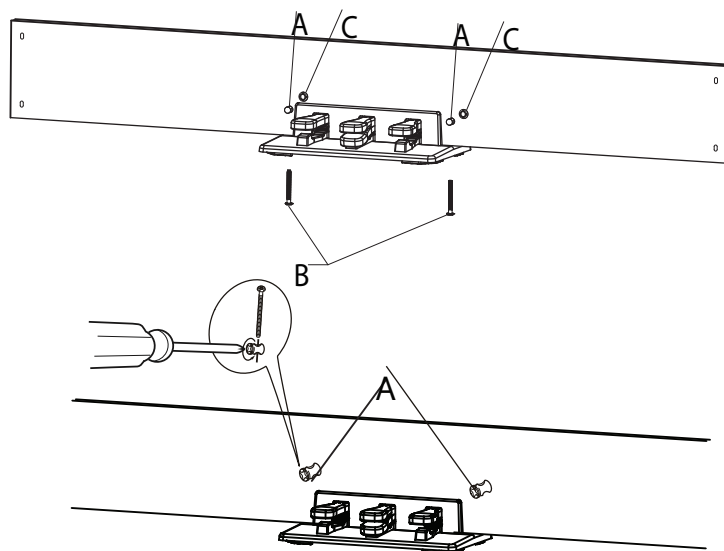

## 2. Attaching the Stand.

Begin assembling the piano by attaching the legs to the Pedal Board.

### Step 1

Position the Pedal Board, by aligning the threaded lugs in the end of the Pedal Board with the holes toward the bottom rear of the Stand Leg.

### Step 2

Thread the Bolt Screws (D) through the Stand Leg into the Pedal Board lugs, as shown.

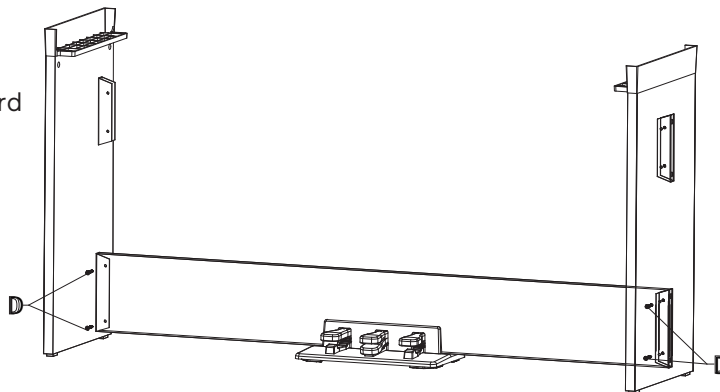

### PLEASE NOTE

*When installing, please rotate the screw slowly, pay attention not to overtighten the screw, and then adjust the position of the pedal until it is in parallel with the ground. Then tighten the screw.*

## 3. Attaching the Cross Piece to the Stand Legs.

### Step 1

Position the Cross Piece, by aligning the threaded lugs in the end of the Cross Piece with the holes toward the top rear of the Stand Leg.

### Step 2

Thread the Bolt Screws (D) through the Stand Leg into the Cross Piece lugs.

### Step 3

Repeat the operation on the other Stand Leg.

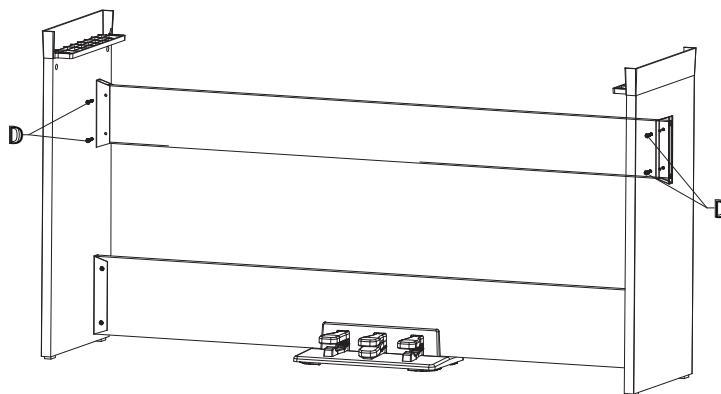

## 4. Attaching the Piano to the Stand.

### Step 1

Lift the piano onto its stand and align the holes in the stand legs with the holes on the bottom of the piano.

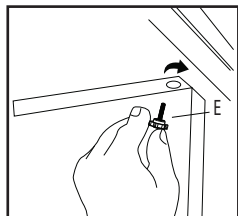

### Step 2

Insert the hand bolts (E) into each hole to attach the piano to its stand as shown in the insert picture.

### Step 3

Finish assembly by covering the locking nuts with Screw Caps (C).

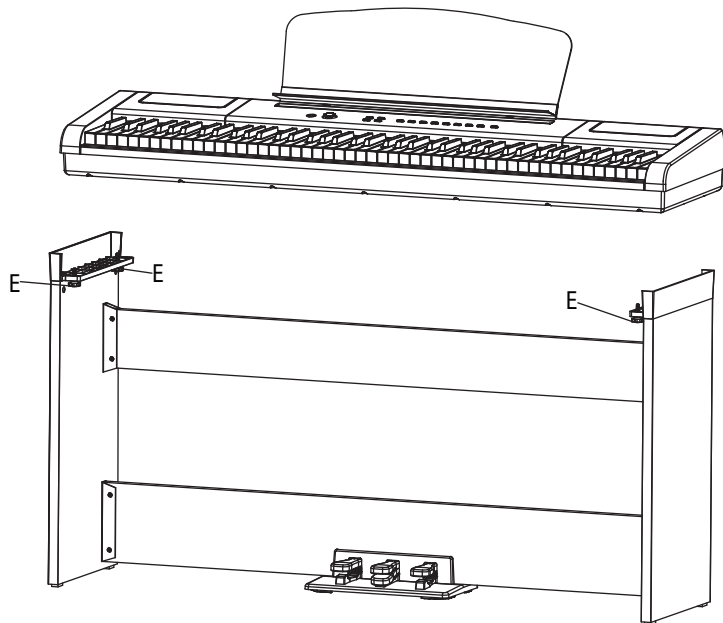

If you have any questions about your piano please contact us toll free at:

**888-998-9848**

**artesia**

Virgin (VMI) is the Parent Company of Artesia Pianos  
Virgin Musical Instrument Company  
P.O. Box 2908  
LA MESA, CA 91943  
info@virginmusicalinstruments.com  
www.virginmi.com